

THIS COPY IS PROVIDED ON A RESTRICTED BASIS AND IS NOT TO BE USED IN ANY WAY DETRIMENTAL TO THE INTERESTS OF PANDUIT CORP.

PANDUIT PART NO.	WEIGHT
FCE2U	19.75 LBS/EACH 9.0 Kg/EACH

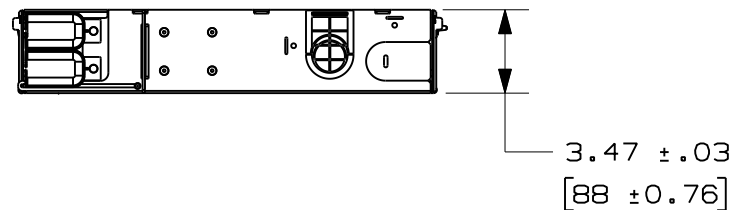
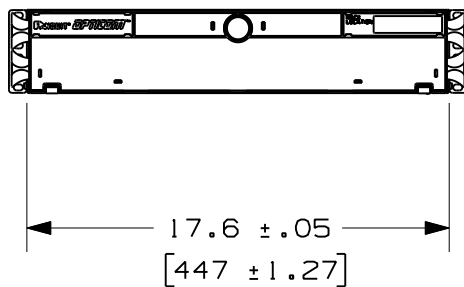
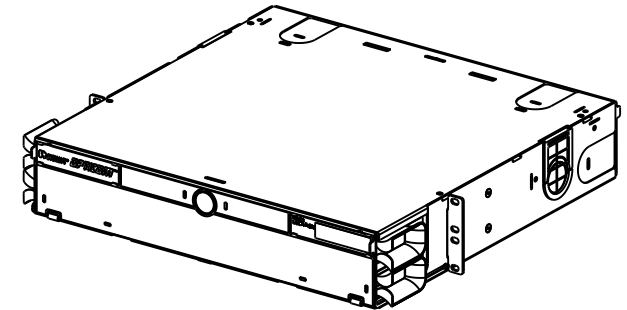
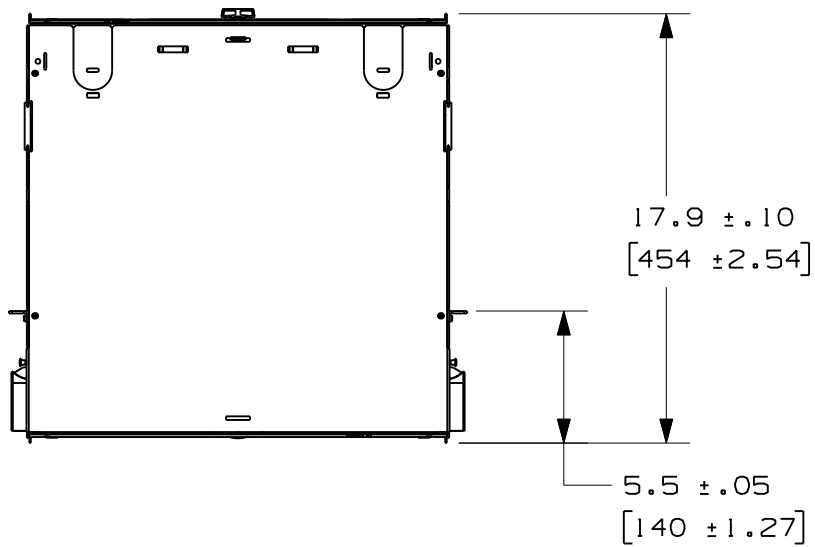

REV	DATE	BY	CHK	DESCRIPTION	ECN	R	CUST	SUP	OTH
01	10-24-12	JESA	WJM	RELEASED	10422-39				

FIBER CASSETTE ENCLOSURE 2RU (FCE2U)
CUSTOMER DRAWING



PANDUIT™
CORP.
TINLEY PARK, ILL 60477

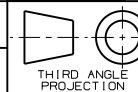

ALL DIMENSIONS ARE GIVEN IN INCHES
UNLESS OTHERWISE SPECIFIED.
DIMENSIONAL TOLERANCES ARE:
(.X) ± .03 | (.XXX) ± .010 | (.3)
(.XX) ± .03 | (.8) ANGLES

DRAWING FILENAME
V10422AE_DC/12A

SCALE
1:8

DRAWN BY
MAV

REVIEW DRAWING NUMBERS

PART NO.
FCE2U



DATE
11-6-07

DRAWING NO.
10422-39

CHK'D

SIZE
A

THIS COPY IS PROVIDED ON A RESTRICTED BASIS AND IS NOT TO BE USED IN ANY WAY DETRIMENTAL TO THE INTERESTS OF PANDUIT CORP.

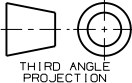
REV	DATE	BY	CHK	DESCRIPTION	REV	DATE	BY	CHK	DESCRIPTION	
					FIBER CASSETTE ENCLOSURE 2RU (FCE2U) CUSTOMER DRAWING					
										TINLEY PARK, ILL 60477
							THIRD ANGLE PROJECTION		DRAWING FILENAME V10422AE_DC/12A	
							ALL DIMENSIONS ARE GIVEN IN INCHES UNLESS OTHERWISE SPECIFIED.		SCALE 1:8	
							DIMENSIONAL TOLERANCES ARE: (.X) ±.03 (.XXX) ±.010 (.3)		PART NO. FCE2U	
01	10-24-12	JESA	WJM	UPDATED TITLE BLOCK AND CAD MODEL			DRAWN BY MAV		DRAWING NO. 10422-39	
00	11-6-07	MAV		RELEASED			DATE 11-6-07		SHEET 2 OF 2	
							CHECK'D		SIZE A	